

EF POWER



По вопросам продаж и поддержки обращайтесь:

Алматы (7273)495-231
Архангельск (8182)63-90-72
Астрахань (8512)99-46-04
Барнаул (3852)73-04-60
Белгород (4722)40-23-64
Брянск (4832)59-03-52
Владивосток (423)249-28-31
Волгоград (844)278-03-48
Вологда (8172)26-41-59
Воронеж (473)204-51-73
Екатеринбург (343)384-55-89
Иваново (4932)77-34-06
Ижевск (3412)26-03-58
Иркутск (395)279-98-46
Россия (495)268-04-70

Казань (843)206-01-48
Калининград (4012)72-03-81
Калуга (4842)92-23-67
Кемерово (3842)65-04-62
Киров (8332)68-02-04
Краснодар (861)203-40-90
Красноярск (391)204-63-61
Курск (4712)77-13-04
Липецк (4742)52-20-81
Магнитогорск (3519)55-03-13
Москва (495)268-04-70
Мурманск (8152)59-64-93
Набережные Челны (8552)20-53-41
Нижний Новгород (831)429-08-12
Киргизия (996)312-96-26-47

Новокузнецк (3843)20-46-81
Новосибирск (383)227-86-73
Омск (3812)21-46-40
Орел (4862)44-53-42
Оренбург (3532)37-68-04
Пенза (8412)22-31-16
Пермь (342)205-81-47
Ростов-на-Дону (863)308-18-15
Рязань (4912)46-61-64
Самара (846)206-03-16
Санкт-Петербург (812)309-46-40
Саратов (845)249-38-78
Севастополь (8692)22-31-93
Симферополь (3652)67-13-56
Казахстан (7172)727-132

Смоленск (4812)29-41-54
Сочи (862)225-72-31
Ставрополь (8652)20-65-13
Сургут (3462)77-98-35
Тверь (4822)63-31-35
Томск (3822)98-41-53
Тула (4872)74-02-29
Тюмень (3452)66-21-18
Ульяновск (8422)24-23-59
Уфа (347)229-48-12
Хабаровск (4212)92-98-04
Челябинск (351)202-03-61
Череповец (8202)49-02-64
Ярославль (4852)69-52-93



GASOLINE PRODUCTS

◆ Generator

Portable Generator.....	01—08
Welding Generator.....	09—10
Big Generator.....	11—12
Inverter Generator.....	13—16

◆ Water pump

Semi-Trash Pump.....	17—18
Trash Pump.....	19—20
High Lift Pump.....	21—22
Chemical Pump.....	23—24

◆ Engine.....25—28

DIESEL PRODUCTS

◆ Generator.....	29—30
◆ Welding Generator.....	31—32
◆ Water Pump.....	33—34
◆ Engine.....	35—38



COMPANY PROFILE

Chongqing YIHU Engine Machinery Co., Ltd. was established in 2004, located at No. 997 Gaoteng Avenue, Hangu High-end Equipment Manufacturing Industrial Park, Jiulongpo District, Chongqing of China.

We are focusing on the research and development, manufacturing and sales of gasoline and diesel engines, generator sets and water pump units. Our products can meet the certification requirements of different places, are certificated by the EPA, CSA, GS, CE certification ... etc. The company has passed ISO9001: 2015 quality management system certification, ISO14001: 2015 environmental management protection system certification, and OHSAS18001: 2007 Occupational health and safety management system certification.

After years of efforts, we have occupied a dominant position in the generator market in China. Meanwhile, we are exporting to the overseas markets, have business in more than 60 countries and regions all over the world, build long-term partnership with some customers, the only reason for our existing is to meet and beyond the customer demands.

PORTABLE GENERATOR V TYPE

- Powerful Engine, Reliable and Durable**
- Low Oil Shut Down Protection**
- New Appearance Design, More Compact**
- AVR Automatic Voltage Regulator**
- Overload Protection**
- 100% Copper Motor**



Model#	V2500	V3000	V3600	V4000	V5500	V6500	V7500	V9500	V10800
Engine Model#	YH170F		YH170FB	YV275F	YH190F		YH192F	YH192FB	
Displacement (cc)	212		223	275	420		439	458	
Starting Type	Recoil/Electric				Recoil/Electric				
Rated Output(KW)	2.0	2.5	2.8	3.3	4.0	5.0	6.0	7.0	8.0
Max Output(KW)	2.2	2.8	3.0	3.6	4.5	5.5	6.5	7.5	8.5
Voltage(V)	110-240				110-240				
Rated frequency(Hz)	50/60				50/60				
VOLT. REG. SYSTEM	AVR				AVR				
Fuel Tank Material	Metal				Metal				
Fuel Tank Capacity (L)	15				25				
Package Type	Carton				Carton				
Package Size (mm)	615*450*485				615*465*495	720*540*595			
Net Weight (Kg)	47	49	50	52	56	86	90	94	98
Loading Quantity (20GP/40HQ)	180/485				136/280				

PORTABLE GENERATOR RD TYPE

- Powerful Engine, Reliable and Durable
- Low Oil Shut Down Protection
- New Appearance Design, More Compact
- AVR** Automatic Voltage Regulator
- Overload Protection
- 100% Copper Motor



Model#	RD2500	RD3000	RD3600	RD4000	RD5500	RD6500	RD7500	RD9500	RD10800
Engine Model#	YH170F		YH170FB		YV275F	YH190F		YH192F	YH192FB
Displacement (cc)	212		223		275	420		439	458
Starting Type	Recoil/Electric								
Rated Output(KW)	2.0	2.5	2.8	3.3	4.0	5.0	6.0	7.0	8.0
Max Output(KW)	2.2	2.8	3.0	3.6	4.5	5.5	6.5	7.5	8.5
Voltage(V)	110-240								
Rated frequency(Hz)	50/60								
VOLT. REG. SYSTEM	AVR								
Fuel Tank Material	Metal								
Fuel Tank Capacity (L)	15				25				
Package Type	Carton								
Package Size (mm)	605*445*500				615*465*495		695*525*580		
Net Weight (Kg)	49	51	52	54	56	90	94	98	102
Loading Quantity (20GP/40HQ)	192/485				180/485		140/292		

PORTABLE GENERATOR FD TYPE

- Powerful Engine, Reliable and Durable**
- Low Oil Shut Down Protection**
- New Appearance Design, More Compact**
- AVR Automatic Voltage Regulator**
- Overload Protection**
- 100% Copper Motor**



Model#	FD2500	FD3000	FD3600	FD4000	FD5500	FD6500	FD7500	FD9500	FD10800
Engine Model#	YH170F		YH170FB		YV275F	YH190F		YH192F	YH192FB
Displacement (cc)	212		223		275	420		439	458
Starting Type	Recoil/Electric								
Rated Output(KW)	2.0	2.5	2.8	3.3	4.0	5.0	6.0	7.0	8.0
Max Output(KW)	2.2	2.8	3.0	3.6	4.5	5.5	6.5	7.5	8.5
Voltage(V)	110-240								
Rated frequency(Hz)	50/60								
VOLT. REG. SYSTEM	AVR								
Fuel Tank Material	Metal								
Fuel Tank Capacity (L)	15				25				
Package Type	Carton								
Package Size (mm)	615*450*485				615*465*495		720*540*595		
Net Weight (Kg)	46	48	49	51	56	86	90	94	98
Loading Quantity (20GP/40HQ)	180/485				136/280				



PORTABLE GENERATOR YH TYPE

- Powerful Engine, Reliable and Durable
- Low Oil Shut Down Protection
- New Appearance Design, More Compact
- AVR** Automatic Voltage Regulator
- Overload Protection
- 100% Copper Motor



Model#	YH2500	YH3000	YH3600	YH4000	YH5500	YH6500	YH7500	YH9500	YH10800
Engine Model#	YH170F		YH170FB	YV275F	YH190F	YH192F	YH192FB		
Displacement (cc)	212		223	275	420	439	458		
Starting Type	Recoil/Electric								
Rated Output(KW)	2.0	2.5	2.8	3.3	4.0	5.0	6.0	7.0	8.0
Max Output(KW)	2.2	2.8	3.0	3.6	4.5	5.5	6.5	7.5	8.5
Voltage(V)	110-240								
Rated frequency(Hz)	50/60								
VOLT. REG. SYSTEM	AVR								
Fuel Tank Material	Metal								
Fuel Tank Capacity (L)	15				25				
Package Type	Carton								
Package Size (mm)	605*445*500				615*465*495		695*525*580		
Net Weight (Kg)	49	51	52	54	56	90	94	98	102
Loading Quantity (20GP/40HQ)	192/485				180/485		140/292		



Welding Generator

-  Powerful Engine Driven, Reliable and Durable
-  Power for Stick, TIG, MIG And Flux-Cored Welding
-  Great for Farm, Ranch, Maintenance, and Construction.
-  Perfect for Transporting on Truck or Trailer for Outdoor Use .
-  Power for Fans, Pumps, Air Compressors or Other Electrical Tools Commonly Found on Job Sites.



Model#	YHMFV-130i	YHMFV-260i	YHMFV-300i	YHW-230A	
Engine Model#	YH170F	YH192F	YH192FB	YH192F	
Displacement (cc)	212	439	458	439	
Starting Type	Recoil/Electric				
Generator Condition	Rated Output(kW)	DC 2.0		AC 5.5	
	Voltage(V)	DC 220		AC 230	
Welding Condition	Rated Voltage (V)	24.4	22.4-27.2	22.8-30	21.6-27.2
	No-Load Voltage (V)	65	70	70	75
	Max.Welding Current(A)	120	210	250	210
	Rated Welding Current (A)	110	180	200	180
	Output Current Range (A)	50-110	60-180	60-200	40-180
	Welding Rod(mm)	2.0-3.2	2.0-5.0	2.0-6.0	2.0-5.0
Fuel Tank Material	Metal				
Fuel Tank Capacity (L)	13	25	25	25	
Package Type	Carton				
Package Size (mm)	565*435*480	720*535*595		695*555*585	
Net Weight (Kg)	37	72	90	98	
Loading Quantity (20GP/40HQ)	208/540	132/264	132/264	128/272	

Big Generator

-  Powerful Engine, Reliable and Durable
-  Low Oil Shut Down Protection
-  New Appearance Design, More Compact
- AVR** Automatic Voltage Regulator
-  Overload Protection



Model#	YH13000	YH18000	YH20000
Engine Model#	YH2V80F	LC2V90F	LC2V90F
Displacement (cc)	713	999	999
Starting Type	Electric Start		
Rated Output(KW)	10	15	18
Max Output(KW)	11	17	20
Voltage(V)	110V - 240V		
Rated frequency(Hz)	50/60		
VOLT. REG. SYSTEM	AVR		
Fuel Tank Material	Metal		
Fuel Tank Capacity (L)	32		
Package Type	Carton+Wooden Pallet		
Package Size (mm)	1010*770*990	1150*890*1010	1150*890*1010
Net Weight (Kg)	175	245	265
Loading Quantity (20GP/40HQ)	30/66	24/52	24/52



SILENT INVERTER GENERATOR



Light Weight
Easy to Carry
Easy to Move



Powerful Engine,
Reliable and
Durable



Super Silent,
Provide You a
Peaceful and
Eco-Friendly
Environment



Parallel Design,
Great Solution
for Your Outdoor
Needs



Multi-function
Power Supply,
More Fuel
Efficient



Pure Sin Wave
Output, Current
Output Quality
is Better and
Stable



YH2200i



YH3500i



YH4500i

Model#	YH2200i	YH3500i	YH4500i
Engine Model#	YH80i	YH152i	YH175i
Displacement (cc)	79.8	152	175
Starting Type	Recoil	Recoil/Electric/Remote	
Rated Output(KW)	1.8	2.8	3.5
Max Output(KW)	2.0	3.2	3.8
Voltage(V)	120-240		
Rated frequency(Hz)	50/60		
Fuel Tank Capacity (L)	4.3	6	7
Oil Capacity (L)	0.35	0.6	0.6
Noise Level@50% Load (dB)7m	62	62	64
THD (%)	< 2%		
Package Type	Carton		
Package Size (mm)	495*320*490	540*360*520	605*370*585
Net Weight (Kg)	18.5	23	27
Loading Quantity (20GP/40HQ)	324/835	248/650	216/470



OPEN FRAME INVERTER GENERATOR

-  Small Size, Light Weight
-  Powerful Engine, Reliable and Durable
-  Low Noise and Low Vibration
-  Parallel Function
-  More Customization Design Options
-  More Fuel-efficient
-  Pure Sin Wave Output, Current Output Quality is Better and Stable



Remote Start



Digital Meter



Circuit Breaker



USB

Model#	YH4000io	YH5000io	YH6500io	YH12000io
Engine Model#	YH170F	YH170FB-V	YH275F	YH192FB-V
Displacement (cc)	212	223	275	458
Starting Type	Recoil/Electric/Remote			
Rated Output(KW)	2.8	3.5	5.0	9.0
Max Output(KW)	3.0	4.0	5.5	9.5
Rated frequency(Hz)	50/60			
Voltage(V)	120-240			
Fuel Tank Capacity (L)		10		25
Oil Capacity (L)		0.6		1.2
Noise Level@50% Load (dB)	72		74	76
THD (%)	< 3%			
Package Type	Carton			
Package Size (mm)	448*395*460	448*395*480	465*510*485	685*515*560
Net Weight (Kg)	26	30	37	76
Loading Quantity (20GP/40HQ)	350/750	280/650	192/480	128/264

GASOLINE WATER PUMP

Semi-Trash Pump



Powerful Engine, Reliable and Durable



New Appearance Design, More Compact



Solid Aluminum Alloy Pump Body



High-quality Ceramic Mechanical Seal







More Fuel-efficient



Model#	WP10	WP15	WP20	WP30	WPA40	WPB40	WP60
Pump	1"	1.5"	2"	3"	4"	4"	6"
Pump type	SEMI-TRASH WATER PUMP						
Engine Model#	YH152F		YH170F		YH177F	YH192F	
Displacement (cc)	97		212		270	439	
Starting Type	Recoil start						
Suction Port Diameter (mm)	25	40	50	80	100		150
Discharge Port Diameter (mm)	25	40	50	80	100		150
Suction Head Lift (m)	5		7				
Max. Lift Head (m)	10	17	32	30	25	30	25
Max Flow (m ³ /h)	5	11	32	56	70	93	150
Accessories	Spark plug Wrench*1, connector*2, adaptor*1						
Package Type	Carton						
Package Size(mm)	365*300*380		485*390*425	535*415*445	560*445*525	655*530*565	755*545*700
Net Weight(Kg)	13	13	25	27	35	46	80
Loading Qty (20GP/40HQ)	684/1638		360/864	300/732	208/520	140/292	120/264

GASOLINE WATER PUMP Trash Pump

-  Powerful Engine, Reliable and Durable
-  New Appearance Design, More Compact
-  Solid Aluminum Alloy Pump Body
-  High-quality Ceramic Mechanical Seal
-  More Fuel-efficient

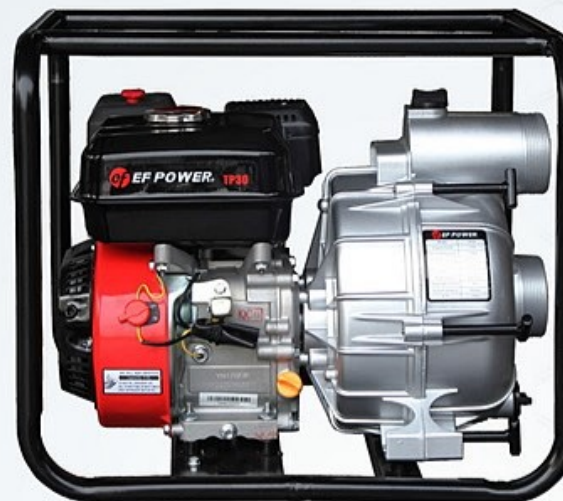

Model#	TP30	
	3"	4"
Pump	TRASH PUMP	
Pump type	Aluminum self-priming pump	
Engine Model#	YH170F	YH190F
Displacement (cc)	212	420
Starting Type	Recoil start	
Suction Port Diameter (mm)	80	100
Discharge Port Diameter (mm)	80	100
Suction Head Lift (m)	7	7
Max. Lift Head (m)	28	25
Max Flow (m ³ /h)	60	100
Accessories	Spark plug Wrench*1, connector*2, adaptor*1	
Package Type	Carton	
Package Size(mm)	575*455*485	655*530*565
Net Weight(Kg)	37	48
Loading Qty (20GP/40HQ)	300/732	140/288

GASOLINE WATER PUMP

High Lift Pump



Powerful Engine, Reliable and Durable



New Appearance Design, More Compact



Solid Aluminum Alloy Pump Body



High-quality Ceramic Mechanical Seal



More Fuel-efficient

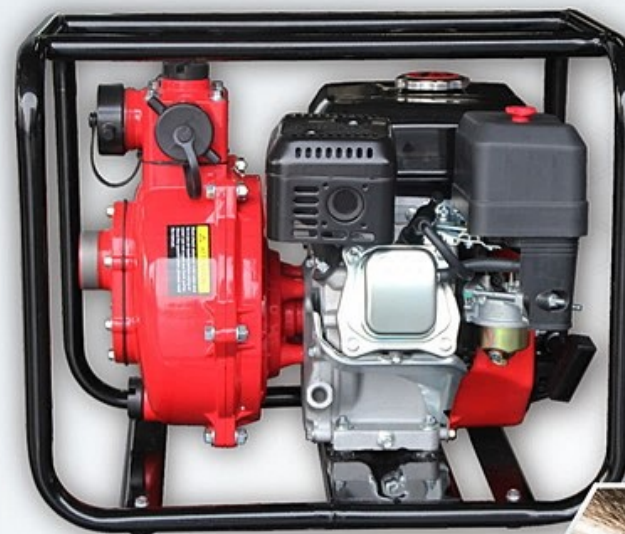

Model#	HP15	HP20	2HP20	HP30
Pump	1.5"	2"		3"
	High Lift Pump			
Pump type	Aluminum self-priming pump			
Engine Model#	YH170F			YH190F
Displacement (cc)	212			420
Starting Type	Recoil start			
Suction Port Diameter (mm)	40	50		80
Discharge Port Diameter (mm)	40	50		65
Suction Head Lift (m)	7			
Max. Lift Head (m)	55		80	70
Max Flow (m ³ /h)	20	30	18	50
Accessories	Spark plug Wrench*1, connector*2, adaptor*1			
Package Type	Carton			
Package Size(mm)	535*415*445			585*505*535
Net Weight(Kg)	27		29	50
Loading Qty (20GP/40HQ)	300/732			140/292

GASOLINE WATER PUMP Chemical Pump



Powerful Engine, Reliable and Durable



New Appearance Design, More Compact



Solid Aluminum Alloy Pump Body



High-quality Ceramic Mechanical Seal



More Fuel-efficient



Model#	CP20	CP30
Pump	2"	3"
	Chemical Pump	
Pump type	Aluminum self-priming pump	
Engine Model#	YH170F	
Displacement (cc)	212	
Starting Type	Recoil start	
Suction Port Diameter (mm)	50	80
Discharge Port Diameter (mm)	50	80
Suction Head Lift (m)	7	
Max. Lift Head (m)	30	20
Max Flow (m ³ /h)	33	60
Accessories	Spark plug Wrench*1, connector*2, adaptor*1	
Package Type	Carton	
Package Size(mm)	555*435*445	615*435*485
Net Weight(Kg)	26	28
Loading Qty (20GP/40HQ)	260/540	180/475



Model#	YH168FA	YH168FB	YH170F	YH170FB	YH173F	YV275F	YH177F	YH188F	YH190F	YH192F	YH192FB	YH2V80F	
Engine Type	Single Cylinder, 4 Strokes, Air Force Cooling											V-Twin Cylinders, 4 Strokes, Air Force Cooling	
Bore*Stroke	68*45	68*54	70*55	70*59	73*58	75*62	77*58	88*64	90*66	92*66	92*69	80*71	
Displacement (cc)	163	196	212	223	242	274	270	389	420	439	458	713	
Compression Ratio	8.5 : 1	8.5 : 1	9.0 : 1	9.0 : 1	8.2 : 1	8.8 : 1	8.5 : 1	8.0 : 1	8.5 : 1	8.5 : 1	8.5 : 1	8.5 : 1	
Rated Output(KW)	3	3.2	4.1	4.5	4.8	6.5	5.4	7.0	7.6	9.0	10	10.5	
Max Output(KW)	3.2	3.6	4.5	5.0	4.9	7	5.8	7.4	7.8	10	11	15	
Starting Type	Recoil											Electric Start	
Fuel Tank Capacity (L)		3.6			6	3.6	6		6.5			N/A	
Oil Capacity (L)		0.6			1.1	0.8		1.1		1.2		1.5	
Ignition System	T.C.I												
Package Type	Carton												
Package Size (mm)		400*370*380			490*420*470	615*465*495		490*420*470	490*420*490			580*540*510	
Net Weight		15			22	55		24	31	31	32	33	45
Loading Quantity (20GP/40HQ)		522/1281			305/660	165/375			305/660			160/440	





DIESEL GENERATOR

-  Low Oil Shut Down Protection
-  Powerful Engine, Reliable and Durable
-  New Appearance Design, More Compact
- AVR** Automatic Voltage Regulator
-  Overload Protection



Model#	YH3800AE	YH7000AE	YH9000AE	YH11000AE
Engine Model#	YH178FA/A-E	YH186FA/A-E	YH192FA/A-E	YH1100F/A-E
Displacement (cc)	296	418	499	667
Starting Type	Recoil/Electric Start			
Rated Output(KW)	2.8	4.5	6.0	8.0
Max Output(KW)	3.0	5.0	7.0	8.5
Voltage(V)	110/220			
Frequency (Hz)	50/60			
Phase	Single Phase			
VOLT. REG. SYSTEM	AVR			
Fuel Tank Material	Metal			
Fuel Tank Capacity (L)	12.5	17		
Continuous Working Time(H)	6.0	7.5	6.5	5.0
Package Type	Carton			
Package Size (mm)	660*460*600	734*487*600		744*541*710
Net Weight (Kg)	63	113	120	140
Loading Quantity (20GP/40HQ)	120/340	96/288		90/192





DIESEL WELDING GENERATOR

-  Powerful Engine Driven, Reliable and Durable
-  Power for Stick, TIG, MIG and Flux-Cored Welding
-  Great for Farm, Ranch, Maintenance, and Construction.
-  Perfect for Transporting on Truck or Trailer for Outdoor Use.
-  Power for Fans, Pumps, Air Compressors or Other Electrical Tools Commonly Found on Job Sites.



Model#		YHW-230AE
Engine Model#		YH192F/A
Displacement (cc)		498
Starting Type		Recoil/Electric
Generator	Rated Output(kW)	5.0
Condition	Voltage(V)	230
	Rated Voltage (V)	22-27.2
Welding Condition	No-Load Voltage (V)	50-65
	Max. Welding Current(A)	230
	Rated Welding Current (A)	180
	Output Current Range (A)	50-230
Welding Rod(mm)		2.0-5.0
Fuel Tank Material		Metal
Fuel Tank Capacity (L)		17
Package Type		Carton
Package Size (mm)		750*550*620
Net Weight (Kg)		123
Loading Quantity (20GP/40HQ)		99/288





DIESEL WATER PUMP

-  Powerful Engine, Reliable and Durable
-  New Appearance Design, More Compact
-  Solid Aluminum Alloy Pump Body
-  High-quality Ceramic Mechanical Seal
-  More Fuel-efficient



Model#	YH50A	YH80A	YH100A
Pump	SEMI-TRASH WATER PUMP		
	2"	3"	4"
Pump type	Aluminum self-priming pump		
Engine Model#	173FA/A		186FA/A
Displacement (cc)	247		418
Suction Port Diameter (mm)	50	80	100
Discharge Port Diameter (mm)	50	80	100
Suction Head Lift (m)	5		
Max. Lift Head (m)	20	19	16
Max. Flow(m ³ /h)	20	30	50
Accessories	Spark plug Wrench*1, connector*2, adaptor*1		
Self Priming Time (s)	≤180		
Efficiency (%)	≥40		
Package Type	Carton		
Package Size(mm)	575*455*485	535*415*445	
Net Weight(Kg)	37	43	73
Loading Qty (20GP/40HQ)	200/500	275/660	

DIESEL ENGINE SERIES

-  Single Cylinder Air Cooled, 4 Stroke Engine
-  The Reliability of Structure and Cooling is Ensured
-  Optimize Fuel System and Intake and Exhaust System to Save Energy and Fuel
-  Compact Structure, Small Size and Light Weight
-  Widely Used in Small Agricultural Machinery, Generator Set, Small Transport Vehicle and Other Fields



PTO SHAFT DIMENSIONS

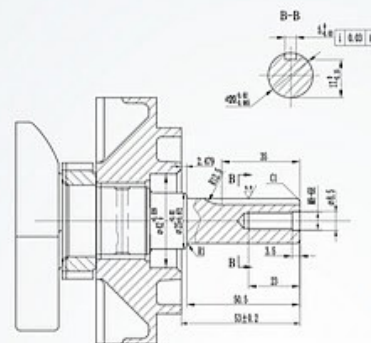

173F
Keyway Shaft

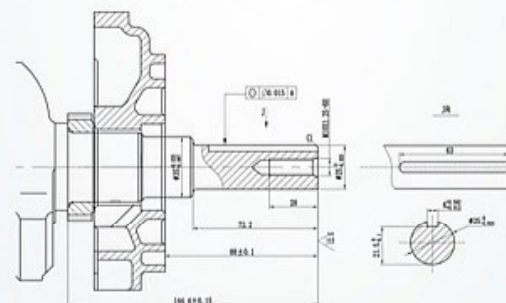

186F/188F/192F
Keyway Shaft

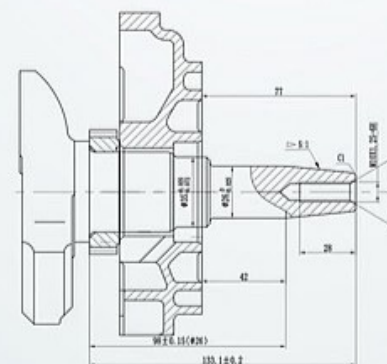

186F/188F/192F
Taper Shaft

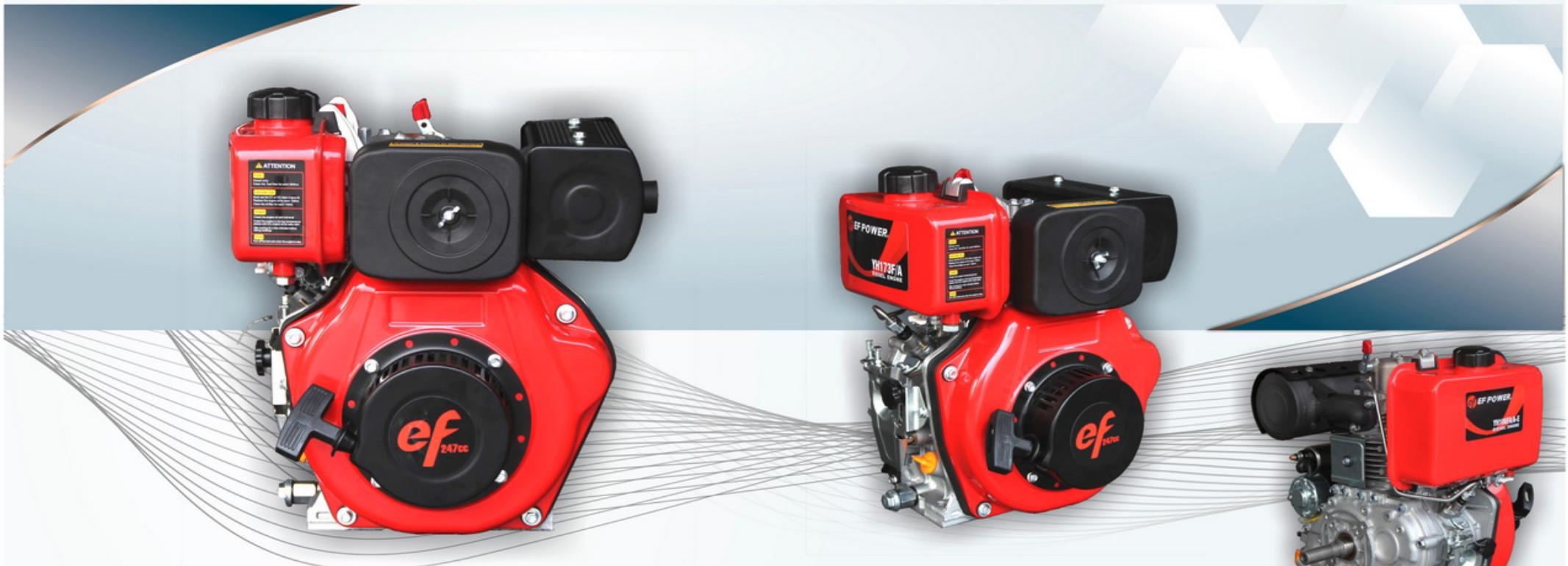

Model#	YH173F/A-(E)	YH178F/A-(E)	YH186FA/A-(E)	YH188F/A-(E)	YH192F/A-(E)	YH195F/A-(E)	YH1100F/A-E	YH292F/A-E
Engine Type	Single Cylinder, 4 Strokes, Air Force Cooling							Double Cylinder, 4 Strokes, Air Force Cooling
Bore*Stroke	73*59	78*62	86*72	88*75	92*75	95*75	100*85	92*75
Displacement (cc)	247	296	418	456	499	531	667	997
Compression Ratio	20:1							19:1
Rated Output(KW)	3.2	3.7	5.7	6.6	7.5	8.0	9.5	14
Max Output(KW)	3.5	4.0	6.3	6.9	8.2	8.8	10.4	15
Fuel Tank Capacity (L)	2.5	3.5				5.5		
Oil Capacity (L)	0.75	1.1	1.65				2.0	2.75
Starting Type	Recoil/Electric						Electric	
Package Type	Carton							
Package Size (mm)	335*380*415	385*420*450	385*420*450	417*441*494			420*490*550	420*490*550
Net Weight	27	33	48	50	52	52	58	78
Loading Quantity (20GP/40HQ)	510/1260	390/840	260/700			244/528		192/400

Алматы (7273)495-231
Архангельск (8182)63-90-72
Астрахань (8512)99-46-04
Барнаул (3852)73-04-60
Белгород (4722)40-23-64
Брянск (4832)59-03-52
Владивосток (423)249-28-31
Волгоград (844)278-03-48
Вологда (8172)26-41-59
Воронеж (473)204-51-73
Екатеринбург (343)384-55-89
Иваново (4932)77-34-06
Ижевск (3412)26-03-58
Иркутск (395)279-98-46
Россия (495)268-04-70

Казань (843)206-01-48
Калининград (4012)72-03-81
Калуга (4842)92-23-67
Кемерово (3842)65-04-62
Киров (8332)68-02-04
Краснодар (861)203-40-90
Красноярск (391)204-63-61
Курск (4712)77-13-04
Липецк (4742)52-20-81
Магнитогорск (3519)55-03-13
Москва (495)268-04-70
Мурманск (8152)59-64-93
Набережные Челны (8552)20-53-41
Нижний Новгород (831)429-08-12
Киргизия (996)312-96-26-47

Новокузнецк (3843)20-46-81
Новосибирск (383)227-86-73
Омск (3812)21-46-40
Орел (4862)44-53-42
Оренбург (3532)37-68-04
Пенза (8412)22-31-16
Пермь (342)205-81-47
Ростов-на-Дону (863)308-18-15
Рязань (4912)46-61-64
Самара (846)206-03-16
Санкт-Петербург (812)309-46-40
Саратов (845)249-38-78
Севастополь (8692)22-31-93
Симферополь (3652)67-13-56
Казахстан (7172)727-132

Смоленск (4812)29-41-54
Сочи (862)225-72-31
Ставрополь (8652)20-65-13
Сургут (3462)77-98-35
Тверь (4822)63-31-35
Томск (3822)98-41-53
Тула (4872)74-02-29
Тюмень (3452)66-21-18
Ульяновск (8422)24-23-59
Уфа (347)229-48-12
Хабаровск (4212)92-98-04
Челябинск (351)202-03-61
Череповец (8202)49-02-64
Ярославль (4852)69-52-93

По вопросам продаж и поддержки обращайтесь: